RA 47

IN-LINE ACTUATOR SERIES

User Manual



 **REGNER®**
Improving lives through technology

www.regner.es

RA 47 IN-LINE ACTUATOR SERIES USER MANUAL

© JUNE 2017 | Regner & Asociados, S.L. | All rights reserved

Specifications are subject to change without prior notice.

It is the responsibility of the product user to determine the suitability of REGNER® products for a specific application.

The product shown in this document is a component without applied parts.

No part of this publication may be reproduced without written permission from Regner & Asociados, S.L.

00. TABLE OF CONTENTS

01. FOREWORD04

02. SAFETY04

03. WARRANTY05

04. SPECIFICATIONS.....05

05. INSTALLATION08

06. MAINTENANCE09

07. TROUBLESHOOTING.....10

08. APPLICATION POLICY11

09. CONTACT11

01. Foreword



Thank you for choosing a REGNER® electric linear actuator. REGNER® actuators are high-end products, carefully designed and manufactured with premium raw materials in Europe. Our products are also continuously improved to correspond better to the demands of our customers.

This manual will familiarize you with operational, maintenance and safety information about the actuator. We urge you to read this manual carefully and follow the recommendations to help assure the highest performance and safe operation.

The REGNER® team

02. Safety

Please read the following safety information carefully and ensure that all the people who will use, connect or install the actuator has the necessary skills, information and access to this user manual.

02.01. Safety instructions

Please follow these safety guidelines:

- Only properly qualified personnel are permitted to perform mechanical and electrical installation of this product.
- Do not mount, dismantle or perform maintenance

work when the actuator is in operation.

- Check the actuator is correctly mounted before operation.
- Check the equipment can move freely throughout the actuator's whole working area before operation.
- Check the actuator is connected to a power supply with the correct voltage and current before operation.
- Ensure that the connection bolts can withstand the wear and they are secured safely before operation.
- Do not sideload the actuator.
- Only use the actuator within the specified working limits.
- Ensure that the usage temperature and duty cycle for the actuator are respected.
- Ensure that the cable cannot be pressed upon, pulled or subjected to any other stress.
- Never unplug any cables or connectors during operation or with power on.
- Immediately stop using the actuator if it seems faulty or broken.
- Never try to open the actuator as that will compromise the sealing and the function of the actuator.
- Do not step on or kick the actuator.
- Switch off the main supply when the actuator is not in use in order to prevent unintentional operation when the actuator is not in use.
- Periodically check the actuator and joints for extraordinary wear.
- Keep out of reach of children.

02.02. Symbols used

Important safety information is described under the following two symbols:



WARNING!

Failing to follow these instructions can cause accidents resulting in serious personal injury.



CAUTION!

Failing to follow these instructions can result in the actuator suffering damage or being destroyed.

03. Warranty

There is a warranty on REGNER® products against manufacturing faults. The warranty period begins on the purchasing date of the product. The seller is responsible for nonconformities that become apparent within the time stipulated by the applicable law.

Warranty exclusions:

REGNER® is entitled to deny any warranty if:







- The actuator has not been correctly used or the actuator usage specifications (load, temperature, duty cycle, voltage, current, etc) have not been respected.
- The actuator has not been correctly maintained.
- The actuator has been tampered with.
- The actuator has been exposed to violent or abrasive treatment.

Nonconformities due to age of the actuator (for example, discolouring of painting) are excluded from warranty.

In case of doubt regarding the existence of a defect or if an inspection is required, REGNER® reserves the right to request the return of the product. Any additional warranty obligations for parts replaced free of charge or for any service provided without charge under this warranty shall be excluded. Warranty of the replaced parts under warranty period will end on the date of expiry of the warranty period of the product concerned.

04. Specifications

04.01. Name plate

		www.regner.es
RA47.2500.100.288.100.D10.P		
Batch. No.:	254857	  
Power Rating:	24 V $\overline{=}$	
Duty Cycle:	Max. 10 % $\frac{2 \text{ min}}{18 \text{ min}}$	
Max. Current:	2.5 A	
		Stroke: 100 mm
		IP Class:
		Max. Load: 2500 N
 WARNING		Improper use may cause damage or injury. Only to be opened by authorized personnel

01. Product ref.: RA47.2500.100.288.150.D10.P

- 01.01. RA47: Actuator Type
- 01.02. 2500: Max. Load (N)
- 01.03. 100: Stroke Length (mm)
- 01.04. 288: Min. Built-in Dimension (mm)
- 01.05. 100: Cable Length (mm)
- 01.06. D: Rod End (D=standard / H=clevis)
- 01.06. 8: Assembly Hole Diameter (mm)
- 01.07. P: Feedback (P= potentiometer & limit switches / L=limit switches)

03. Batch. No.: 254857





Identification number assigned to a particular lot of products that enables REGNER® to control the product quality and tracing of the constituent parts.

04. Actuator specifications: Power Rating, Stroke, Duty Cycle, IP Class, Max. Current, Max. Load.

Basic specifications and actuator features.

05. Symbols.

The following symbols are used on the label.

Symbol	Explanation
	WEEE Directive 2012/19/UE. The symbol indicating separate collection for WEEE: waste of electrical and electronic equipment.
	CE. Compliance to all relevant CE directives
	Safety sign. Operating instructions should be considered when operating the device.
	Protection against electric shock. Class II equipment.

04.02. Terminology

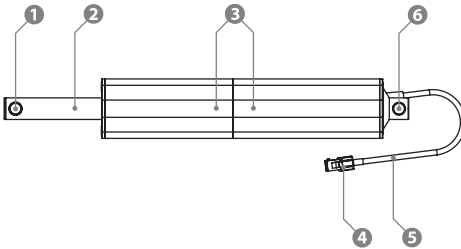

- 1. Rod end
- 2. Rod
- 3. Housing
- 4. Connector
- 5. Cable
- 6. Rear end

04.03. Mechanical specifications

Weight	1250 g
Housing material	Aluminum
Rod Material	Polished stainless steel
Color	Anodized Black
Connector	Molex 39-01-2066

04.04. Actuator specifications

Max. Load	2500 N at 1.9 mm/s
Lead	1.5 mm
Max. Speed (No load)	3.5 mm/s
Max. Current	2.5 A
Starting Current	3 A
Power Supply	24 VDC
Strokes	25 - 150 mm
Duty Cycle	10 % (2 min out of 18)
Lifetime	30.000 cycles at rated load
Limit switches	At stroke endpoints

04.05. Position feedback (optional) specifications

Supply voltage	4.5 - 5.5 VDC
Output voltage	0.3-3.3 VDC \pm 3 %
Current consumption	< 2 mA
Resolution	Infinite
Independant Linearity	\pm 3 %

04.06. Operation environment

Max. Temperature	+40° C (+104° F)
Min. Temperature	+5° C (+41° F)
Max. Relative humidity	90 %
Min. Relative humidity	0 %
Max. Atmospheric pressure	106 kPa
Min. Atmospheric pressure	30 kPa
IP Rating	IP65

04.07. Storage environment

Max. Temperature	+70° C (+104° F)
Min. Temperature	-30° C (+41° F)
Max. Relative humidity	90 %
Min. Relative humidity	0 %
Max. Atmospheric pressure	106 kPa
Min. Atmospheric pressure	30 kPa

04.08. Dimensions

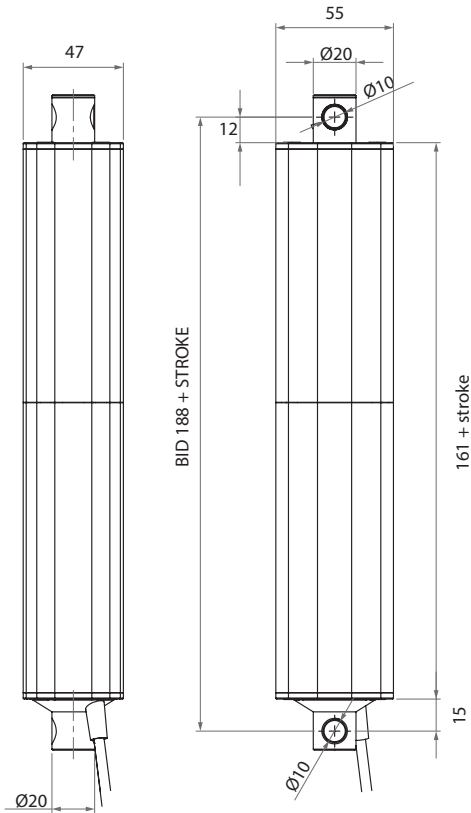

05.09 Force curve

The name values below are typical values set with a stable power supply.

Force (N)	No load	500 N	1000 N	1500 N	2000 N	2500 N
Average Current (A)	0.2	0.9	1.3	1.7	2.1	2.5
Speed (mm/s)	3.5	3.2	2.9	2.6	2.2	2.0

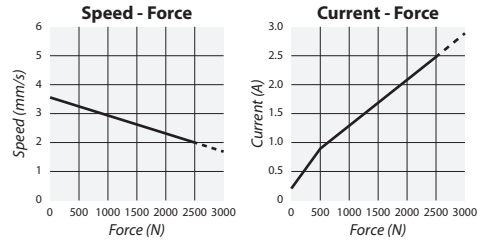

Use in the dashed area is not recommended.
The above figures are with a room temperature of 20°C.

06. Installation

06.01. Mechanical mounting

REGNER® actuators can be easily installed by slipping pins through the holes on each end. Mounting pins must be parallel to each other, otherwise the actuator may bend and result in damage.

It is recommended to install the actuator so the force of the load acts in the center of the extension tube and the rear end. Excessive off-centre loads may cause bending and lead to premature failure.

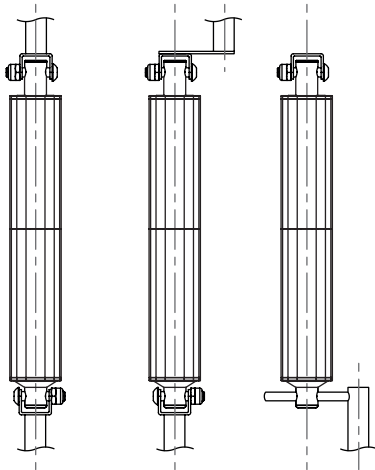

RECOMMENDED

OTHER

OTHER

Make sure the mounting pins are supported in both ends and the pins are solid and without excessive free play to prevent premature wear. However, the actuator must rotate around the pivot point in the front and rear end, this will allow the actuator to move freely over the full stroke length, both during the development and daily operation. Check the area around the housing and make sure no parts can be trapped and cause damage to the application and actuator.



CAUTION!

Mechanical mounting precautions:

- The mounting pins must have the correct dimension, without excessive free play.
- The bolts and nuts must be made of a high quality steel grade.
- Do not use an excessive torque on the mounting bolts to prevent from stressing the fixtures.



WARNING!

If the actuator is used for pull in an application where personal injury can occur, the following is valid: It is the application manufacturer's responsibility to incorporate a suitable safety arrangement, which will prevent personal injury from occurring if the actuator should fail.



WARNING!

REGNER®'s actuators are not designed to be used in the following applications: aircrafts and aerospace, explosive environments, nuclear power generation and offshore installations.

06.02. Electrical installation

Molex 39-01-2066

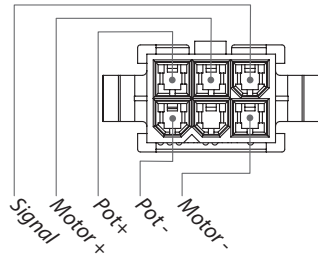

**CAUTION!****Electric installation precautions:**

- Make sure the leads/cables leading to the motor can handle the maximum motor current.
- To increase the actuator's protection use a fuse between the actuator and the power source.
- Never work on the actuator or the wiring with the power switched on!

Actuator

- The actuator voltage must be switched off when reaching the ends of stroke or during a mid-stroke overload to avoid causing damage to the actuator.
- Make sure that the switch can handle the maximum motor current.

Potentiometer feedback (opt.)

- The feedback may operate with different voltages up to 24 VDC. Do not use a higher voltage of 24 VDC.
- Standard output for a 4.5-5.5 VDC is 0.3-3.3 VDC \pm 3%. The use of another current will directly modify these values.

Wire cross sections

To avoid malfunction due to voltage drop, the cross section of the wires between the actuator motor and the power source must be of sufficient size to avoid voltage loss.

07. Maintenance

The actuator is a closed unit and requires no internal maintenance. Furthermore, the actuator is not to be opened by unauthorised personnel. However, some external maintenance must be performed:

- The actuator must be cleaned at regular intervals with a dry cloth to remove dust and dirt, and inspected for mechanical damages or wear.
- Inspect attachment points, cables, rod ends, housing and connector, as well as check that the actuator functions correctly.

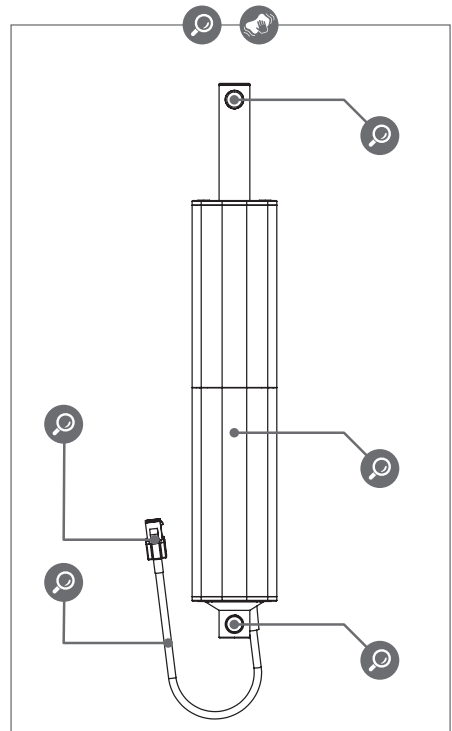

08. Troubleshooting

Symptom	Possible cause	Action
<i>No motor sound or movement of piston rod.</i>	<ol style="list-style-type: none"> 1. The actuator is not properly connected to the power supply. 2. Customer fuse burned. 3. Cable damaged. 	<ol style="list-style-type: none"> A. Check the connection to the power supply or the external control unit (if any). B. Check wire connection on control unit. C. Please contact REGNER®.
<i>Excessive electricity consumption.</i>	<ol style="list-style-type: none"> 1. Misalignment or overload in application 	<ol style="list-style-type: none"> A. Align or reduce load. B. Try to run the actuator without load. C. Please contact REGNER®.
<i>Actuator cannot lift full load.</i>	<ol style="list-style-type: none"> 1. Misalignment or overload in application 2. Insufficient power supply. 3. Current cut off (overload in the application). 4. Motor is damaged. 	<ol style="list-style-type: none"> A. Wait 5 minutes to reset the overcurrent protection system. A. Align or reduce load. B. Check the power supply. C. Please contact REGNER®.

<i>Motor runs too slowly, does not run with full force or runs in smaller steps.</i>	<ol style="list-style-type: none"> 1. Load is higher than specified. 2. Voltage drop in cable (long cables may affect the performance). 3. Current cut off (overload in the application). 	<ol style="list-style-type: none"> A. Wait 5 minutes to reset the overcurrent protection system. B. Reduce load. C. Check power supply.
<i>Motor runs but spindle does not move.</i>	<ol style="list-style-type: none"> 1. Gearing system or spindle damaged. 	<ol style="list-style-type: none"> A. Please contact REGNER®.
<i>Actuator(s) cannot hold the chosen load</i>	<ol style="list-style-type: none"> 1. The load is higher than specified. 	<ol style="list-style-type: none"> A. Reduce load.
<i>Potentiometer feedback, no output signal.</i>	<ol style="list-style-type: none"> 1. The actuator is not properly connected to the power supply. 2. Customer fuse burned. 3. Cable damaged. 	<ol style="list-style-type: none"> A. Check the connection to the power supply or the external control unit (if any). B. Check wire connection on control unit. C. Please contact REGNER®.
<i>Potentiometer feedback output signal out of range</i>	<ol style="list-style-type: none"> 1. Incorrect power supply. 	<ol style="list-style-type: none"> A. Check and correct power supply. B. Please contact REGNER®.

09. Application policy

The purpose of the application policy is to define areas of responsibilities in relation to applying a REGNER® product related to a customer application. REGNER® products are applicable for a wide range of applications (including healthcare, household equipment, and industrial areas). REGNER® cannot know and check all the conditions under which REGNER® products will be installed and used. So the suitability and functionality of the REGNER® product and its performance under different conditions can only be verified by testing, and shall ultimately be the responsibility of the REGNER® customer using any REGNER® product.

REGNER® shall be responsible solely that REGNER® products comply with the specifications set out by REGNER® and it shall be the responsibility of the REGNER® customer to ensure that the specific REGNER® product can be used for the application in question.

10. Contact

For technical assistance get in touch with the REGNER® technical department through the following e-mail: info@regner.es.

